



SUGIYAMA ELECTRIC SYSTEM INC.

611 Man-cho Nakagawa-ku Nagoya Aichi 454-0872 Japan

TEL : 81-52-363-0501 FAX: 81-52-351-7585

Contact Sensors

Series of USE

USE series is enlargement spec of spring type contact sensor such as US-1(USD-1), US-2(USD-2).

USE-E and USE-DE make the cable of US series, USD series and USE series extend.

USE-1

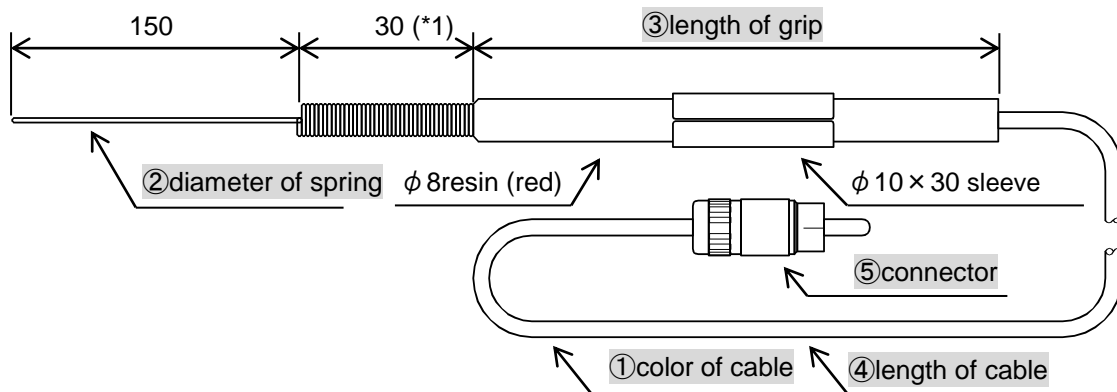

(*1) Length is set to 35 when the diameter of a spring is φ0.8mm.

Model Code : USE-1 - BU 08 L 3000 P

① ② ③ ④ ⑤

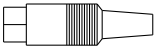
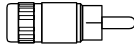
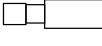
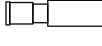

| ① color of cable | | ② diameter of spring | | ③ length of grip | | ④ length of cable | | ⑤ connector | | | | | |
|------------------|--------|----------------------|----------|------------------|--------|---|--------|-------------|---|--|---|---|--------------------|
| code | color | code | diameter | code | length | code | length | code | form of connector | | | | |
| BU | Blue | 05 | φ 0.5mm | L | 98mm | Please specify the length what you need. (Maximum 3000mm. Use the millimeter unit. Tolerance ± 15%.) | | DP |  DIN plug | | | | |
| R | Red | 08 | φ 0.8mm | S | 50mm | | | | P |  equivalent to CN7017P | | | |
| W | White | 10 | φ 1.0mm | | | | | | | F |  equivalent to PC4009-F | | |
| Y | Yellow | 12 | φ 1.2mm | | | | | | | | M |  equivalent to PC4009-M | |
| P | Pink | 15 | φ 1.5mm | | | | | | | | | N | Without connectors |
| O | Orange | | | | | | | | | | | | |
| BR | Brown | | | | | | | | | | | | |

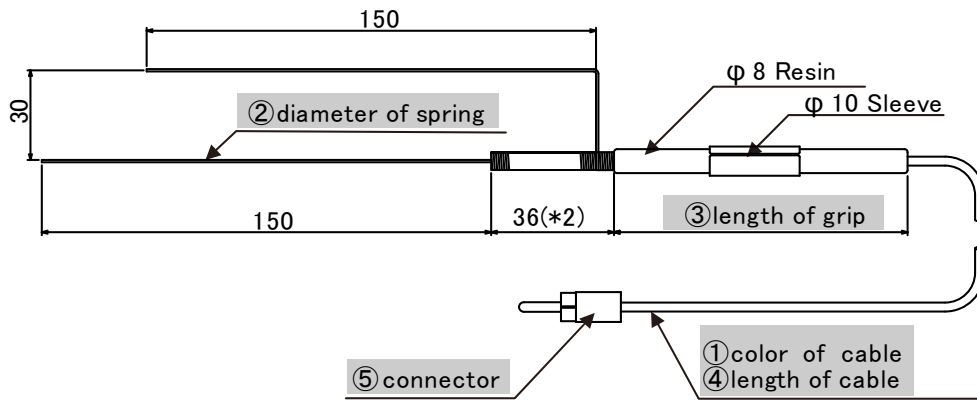
USE-2

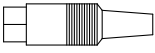
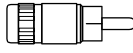

(*2) Length is set to 41 when the diameter of a spring is φ0.8mm.

Model Code : **USE-2- BU 08 L 3000 P**
 ① ② ③ ④ ⑤

| ① color of cable | | ② diameter of spring | | ③ length of grip | | ④ length of cable | | ⑤ connector | | |
|------------------|--------|----------------------|----------|------------------|--------|---|--------|-------------|---|--|
| code | color | code | diameter | code | length | code | length | code | form of connector | |
| BU | Blue | 05 | φ 0.5mm | L | 98mm | Please specify the length what you need. (Maximum 3000mm. Use the millimeter unit. Tolerance ± 15%.) | | DP |  DIN plug | |
| R | Red | 08 | φ 0.8mm | S | 50mm | | | P |  equivalent to CN7017P | |
| W | White | 10 | φ 1.0mm | | | | | F |  equivalent to PC4009-F | |
| Y | Yellow | 12 | φ 1.2mm | | | | | M |  equivalent to PC4009-M | |
| P | Pink | 15 | φ 1.5mm | | | | | N | Without connectors | |
| O | Orange | | | | | | | | | |
| BR | Brown | | | | | | | | | |



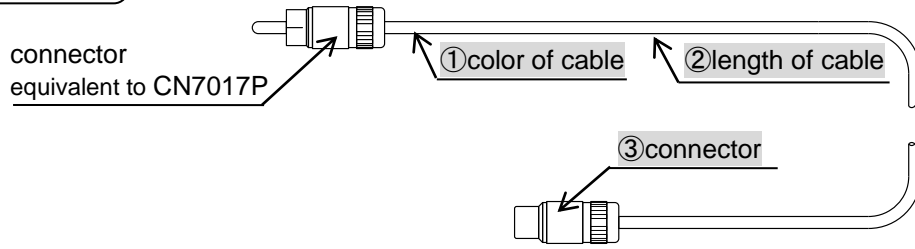

USE-E

A cable of the USE-1 or the US series can be extended by the USE-E.

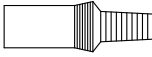

Model Code : **USE-E- BU 3000 J**

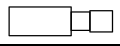
① ② ③

| ① color of cable | | ② length of cable | | ③ connector | |
|------------------|--------|--|--------|-------------|---|
| code | color | code | length | code | form of connector |
| BU | Blue | Please specify the length what you need. (Maximum 3000mm. Use the millimeter unit. Tolerance ± 15%.) | | DJ |  DIN socket |
| R | Red | | | J |  equivalent to CN7018J |
| W | White | | | F |  equivalent to PC4009-F |
| Y | Yellow | | | M |  equivalent to PC4009-M |
| P | Pink | | | N | Without connectors |
| O | Orange | | | | |
| BR | Brown | | | | |



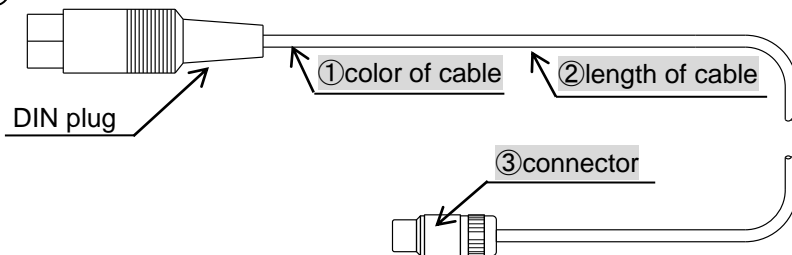

USE-DE

USE-DE is used for PS682(DIN socket) with the same use as USE-E

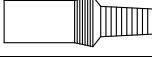

Model Code : **USE-DE- BU 3000 J**

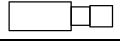
① ② ③

| ① color of cable | | ② length of cable | | ③ connector | |
|------------------|--------|--|--------|-------------|---|
| code | color | code | length | code | form of connector |
| BU | Blue | Please specify the length what you need. (Maximum 3000mm. Use the millimeter unit. Tolerance ± 15%.) | | DJ |  DIN socket |
| R | Red | | | J |  equivalent to CN7018J |
| W | White | | | F |  equivalent to PC4009-F |
| Y | Yellow | | | M |  equivalent to PC4009-M |
| P | Pink | | | N | Without connectors |
| O | Orange | | | | |
| BR | Brown | | | | |